

<b>深圳市钜硕电子有限公司</b> SHENZHEN JUSHUO ELECTRONIC CO.,LTD		文件編號：	<b>JSQA-FPC01086</b>
		修訂日期：	<b>2011-09-18</b>
<b>0.3P 1.0H</b> <b>FPC/FFC</b>	<b>Product Specification</b>	版 次：	<b>Rev A</b>
		頁 次：	<b>1/9</b>

# Product Specification

## 0.3P 1.0H FPC W/COVER BACK-LOCK SMT TYPE.

<b>Approved By</b>	<b>Checked By</b>	<b>Prepared By</b>
JOHNSON	RUANJUN	LUKE

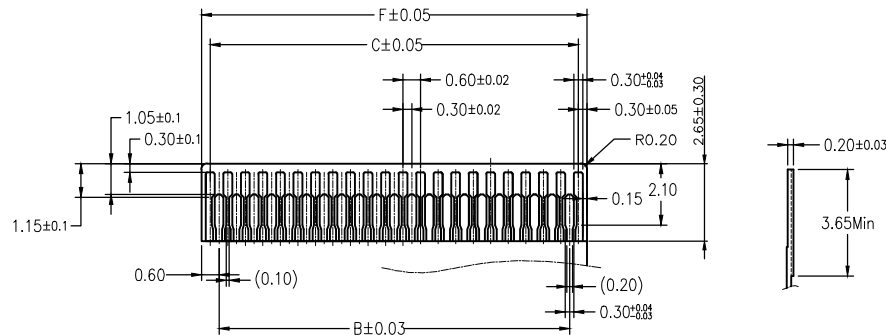
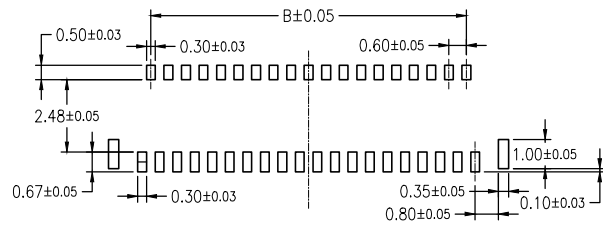
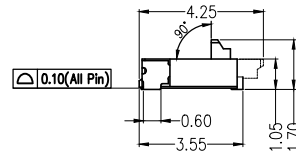
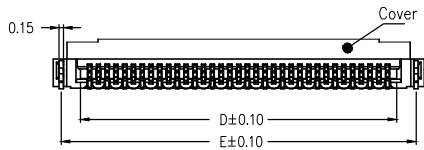
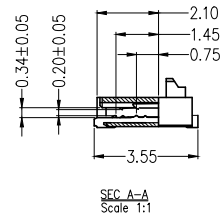
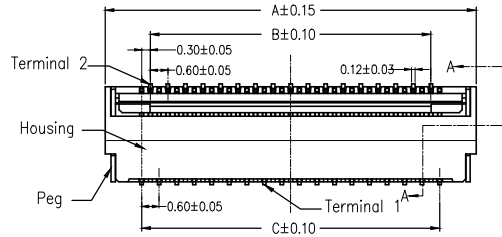

Note:

1.Material

- 1.1: Housing: LCP UL94-V0 Color:Black or White
- 1.2: Actuator: LCP UL94-V0 Color:Black.
- 1.3: Contact: Phosphor Bronze.
- 1.4: LEG: Phosphor Bronze.

2.Plating

- 2.1: Contact: See Part Number.
- 2.2: LEG: Matte Tin Plating Over Nickel.

3.Rating:

- 3.1: Operating Voltage: 30V AC/DC.
- 3.2: Current Rating: 0.2A AC/DC.
- 3.3: Operating Temperature:-55°C~+85°C.

4.Pater Number:

AFH39 - S \*\* F I A -1H

Remarks: 1H=Housing

HF:Halogen free

Packing: A=Tape & rell C=tube

Gold flash l=1u"AU M=5U"AU

Right Angle Double Contact Type

NO.of contacts

Series name

FPC Series Pitch=0.3mm

No. of Contacts	Dimension					
	A	B	C	D	E	F
09	4.90	1.80	2.40	3.03	4.35	3.00
11	5.50	2.40	3.00	3.63	4.95	3.60
13	6.10	3.00	3.60	4.23	5.55	4.20
15	6.70	3.60	4.20	4.83	6.15	4.80
17	7.30	4.20	4.80	5.43	6.75	5.40
19	7.90	4.80	5.40	6.03	7.35	6.00
21	8.50	5.40	6.00	6.63	7.95	6.60
23	9.10	6.00	6.60	7.23	8.55	7.20
25	9.70	6.60	7.20	7.83	9.15	7.80
27	10.30	7.20	7.80	8.43	9.75	8.40
29	10.90	7.80	8.40	9.03	10.35	9.00
31	11.50	8.40	9.00	9.63	10.95	9.60
33	12.10	9.00	9.60	10.23	11.55	10.20
35	12.70	9.60	10.20	10.83	12.15	10.80
37	13.30	10.20	10.80	11.43	12.75	11.40
39	13.90	10.80	11.40	12.03	13.35	12.00
41	14.50	11.40	12.00	12.63	13.95	12.60
43	15.10	12.00	12.60	13.23	14.55	13.20
45	15.70	12.60	13.20	13.83	15.15	13.80
47	16.30	13.20	13.80	14.43	15.75	14.40
49	16.90	13.80	14.40	15.03	16.35	15.20
51	17.50	14.40	15.00	15.63	16.95	15.60

深圳市钜硕电子有限公司

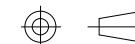

TITLE: 0.3Pitch 1.0H  
品名: 前插后压双面接镀金

一般公差 (TOLERANCE)		APPD: 核准: ZHONGJIAN	DWG NO: 產品料號: AFH39-S*FIA-1H			
X.X ±0.30	X.X' ±5*	CHECK: 校對: LiWEI	DATE	SCALE	UNIT	PAGE
X.XX ±0.20	X.XX' ±2*	DRAW: 繪圖: WANGHAO	20130618	1:1	mm	1/1

本产品需符合  RoHS  SONY00259  HF  其他  
※禁止使用本公司所禁用有毒物质

# EMBOSSED TAPE PACKING

FPC 0.3Pitch 1.0H ZIF R/A Double Contact Connector SMT Type

PULL OUT DIRECTION

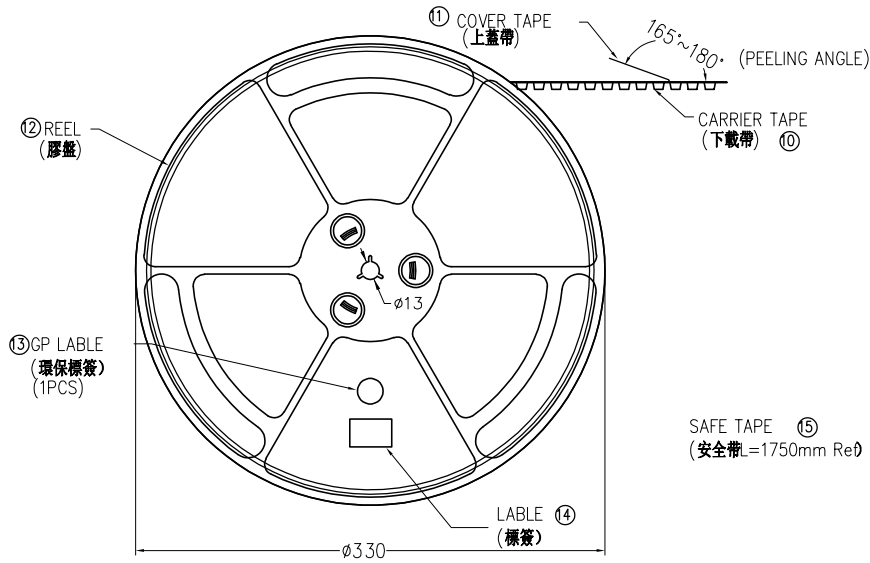

SCALE 1:4

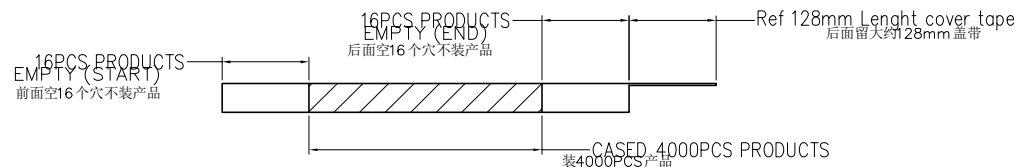
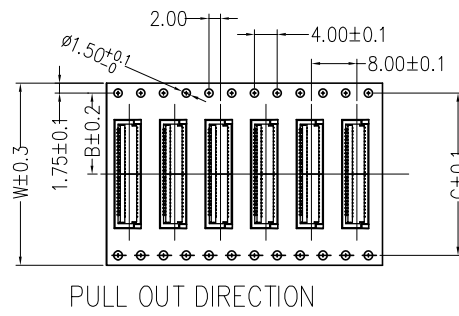
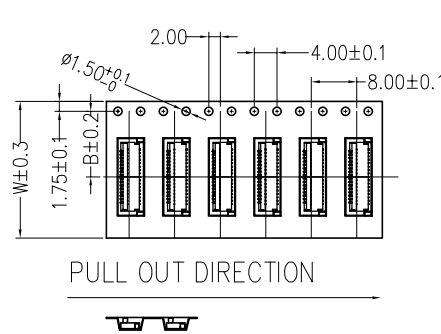

## NOTE:

- 1.10 Sprocket hole pitch cumulative tolerance  $\pm 0.20$ .
2. Carrier camber is within 1mm in 100mm.
3. Material: black conductive polystyrene alloy.
4. Material Thickness:  $0.3 \pm 0.05$ mm.
5. All dimensions meet EIA-481-B requirements.
6. 4000pcs Pef Reel.
7. For tape width(dim W)12,16 and 24mm pilot holes are provided on one sides. For tape width(dim W)32, 44mm pilot holes are provided on both sides.

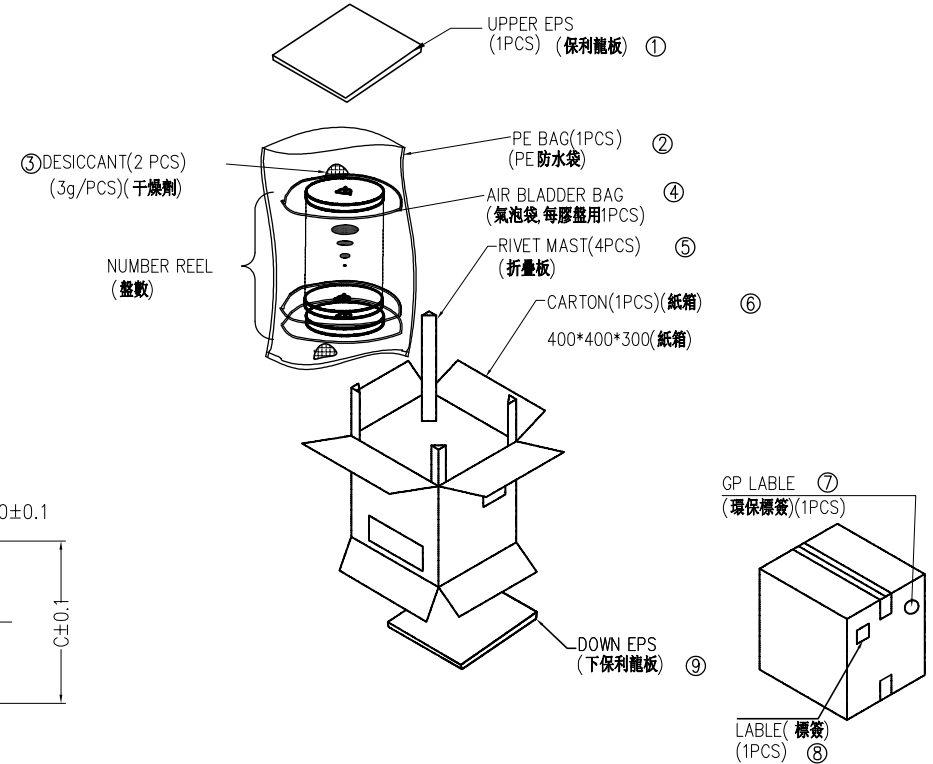

PIN NO.	W	B	C	PCS /REEL	REEL/CARTON	SUM(PCS)
09PIN~25PIN	16		-	4000	13	52000
31PIN~39PIN	24			4000	10	40000
41PIN~51PIN	32			4000	7	28000

## 深圳市钜硕电子有限公司

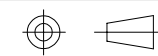

TITLE: 0.3Pitch 1.0H  
品名: 前插后压双面镀金

一般公差 (TOLERANCE)		APPD: 核准: ZHONGJIAN	DWG NO: AFH39-S**FIA-1H
X.X : $\pm 0.30$	X.X* : $\pm 5^*$	CHECK: 校对: LIWEI	DATE: SCALE: UNIT: PAGE:
X.XX : $\pm 0.20$	X.XX* : $\pm 2^*$	DRAW: 繪圖: WANGHAO	20130618 1:1 mm 1/1

本产品需符合 RoHS SONY00259 HF 其他  
※禁止使用本公司所禁用有毒物质

<b>深圳市钜硕电子有限公司</b> SHENZHEN JUSHUO ELECTRONIC CO.,LTD		文件編號：	JSQA-FPC01086
		修訂日期：	2011-09-18
<b>0.3P 1.0H</b> <b>FPC/FFC</b>	<b>Product Specification</b>	版 次：	Rev A
		頁 次：	3/9

## 1. SCOPE

This specification covers the performance, tests and quality requirements for the 0.3mm PITCH 1.0H FPC W/COVER BACK-LOCK SMT TYPE. When tests are performed on the subject product line, the procedures specified specifications shall be used. All inspections shall be performed using the applicable inspection plan and product drawing.

## 2. REQUIREMENTS

### 2.1 PRODUCT DIMENSIONS and APPLICABLE FFC/FPC&PCBLAYOUT

Product shall be of the design, construction and physical dimensions specified on the applicable Product Drawing.

See attached Product Drawing.

### 2.2 MATERIALS

ITEM	DISCRIPTION
Housing(主体)	High-Temp Plastic, UL 94V-0, Halogen Free
Cover(盖子)	High-Temp Plastic, UL 94V-0, Halogen Free
Terminal(端子)	Copper Alloy
Peg(接地片)	Copper Alloy
Terminal Plated(端子电镀)	See Product Drawing Plating Information
Peg Plated(接地片电镀)	

### 2.3 RATINGS

ITEM	STANDARD
Operating Voltage (Max.)	30V AC
Current Rating (Max.)	0.3A DC
Operating Temperature	-55°C~+85° (Including terminal temperature rise)
Operating Humidity range	Relative humidity 90%Max.
Storage temperature range	-10°C ~ +50°C
Storage Humidity range	Relative humidity 90%Max.

<b>深圳市钜硕电子有限公司</b> SHENZHEN JUSHUO ELECTRONIC CO., LTD		文件編號：	JSQA-FPC01086
		修訂日期：	2011-09-18
<b>0.3P 1.0H</b> <b>FPC/FFC</b>	<b>Product Specification</b>	版 次：	Rev A
		頁 次：	4/9

### 3. Test Requirements and Procedures Summary

测试项目(Test Item)		规格(Requirement)		测试方式/条件(Test Condition)
1	外观检查 Examination of Product	符合图面外观，无任何损坏异状 No physical damage.		目视 Visual inspection.
<b>电气特性(Electrical Requirement)</b>				
2	接触阻抗 Contact Resistance	[ 100 ] mΩ 以下. [ 100 ] mΩ Max.		将样品与适合之 FFC/FPC 连接，测试电压 20mV，限电流 10mA 下进行阻抗测试。 Mate applicable FPC and measure by dry circuit, 20mV Max, 10mA. (EIA-364-6B)
3	绝缘阻抗 Insulation Resistance	[ 50 ] MΩ 以上. [ 50 ] MΩ Min.		将样品与适合之 FFC/FPC 连接，提供相邻端子间测试电压 500V DC 进行绝缘阻抗测试。 Mate applicable FPC and apply 500V DC between adjacent terminal and ground. (EIA-364-20B /MIL-STD-202 Method 302)
4	耐电压 Dielectric withstanding Voltage	目视外观无任何损坏异状 No Breakdown		将样品与适合之 FFC/FPC 连接，提供相邻端子间测试电压 500V DC 进行绝缘阻抗测试。 Mate applicable FPC and apply 500V DC between adjacent terminal and ground. (EIA-364-21C /MIL-STD-202 Method 302)
<b>机械特性(Mechanical Requirement)</b>				
5	FFC/FPC 保持力 FFC/FPC Retention Force	Pos. x 0.015Kgf {0.15N} 以上 Pos. x .015Kgf {0.15N} Min.		将盖子盖上与 FFC/FPC 连接，以操作速度每分钟位移 25±3mm 进行 FFC/FPC 保持力测试。 Insert the Cover; pull the FFC/FPC at a rate of 25±3mm per minute (EIA-364-13B).
6	盖子往返操作耐久测试 Repeated Actuator Insertion/ Withdrawal Durability Test	接触阻抗 Contact Resistance	[ 100 ] mΩ 以下. [ 100 ] mΩ Max.	将盖子与 FFC/FPC 反复连接，以每分钟小于 10 cycles 连续操作 10 次。 Insert and withdraw cover up to 10 cycles at the speed rate of less than 10 Cycles/Minute. (EIA-364-9C).
7	耐振性 Vibration	外观 Appearance	目视外观无任何损坏异状 No Damage	通过 DC 电流 1mA，位移相对距离 1.5mm，振动周期 10~55~10 Hz 在 1 分钟内，持续 2 小时，方向在 X,Y,Z 轴做测试。 Mate connectors and subject to the following vibration conditions, for period of 2 hours in each of 3 mutually perpendicular axes, passing DC 1mA during the test. Amplitude : 1.5mm P-P Frequency : 10~55~10 Hz in 1 minute. (EIA-364-28D, Condition I /MIL-STD-202 Method 201)
		接触阻抗 Contact Resistance	[ 100 ] mΩ 以下. [ 100 ] mΩ Max.	
		瞬间断电 Discontinuity	1 μ sec 以下. 1 μ sec Max.	
8	耐冲击性 Mechanical Shock	外观 Appearance	目视外观无任何损坏异状 No Damage	Duration: 2 hours in each of X, Y, Z axes. 将样品与适合之 FFC/FPC 连接，通过 DC 1mA 测试条件，连续测试 3 次。在 X、Y、Z 3 轴 6 个垂直方向施予重力加速度 .490m/s <sup>2</sup> {50G} 冲击。 Mate applicable FFC/FPC and subject to the following shock conditions. 3 times of shocks shall be applied for each 6 directions along 3 mutually perpendicular axes, passing DC 1 mA current during the test. (EIA-364-27B, Method A /MIL-STD-202 Method 108)
		接触阻抗 Contact Resistance	[100] mΩ 以下. [100] mΩ Max.	
		瞬间断电 Discontinuity	1 μ sec 以下. 1 μ sec Max.	

测试项目(Test Item)		规格(Requirement)		测试方式/条件(Test Condition)
<b>环境特性及其他性能(Environment Performance and Others)</b>				
9	耐湿性 Humidity	接触阻抗 Contact Resistance	[ 100 ] mΩ 以下. [ 100 ] mΩ Max.	将样品与适合之 FFC/FPC 连接，置于环境温 60±2°C，相对湿度 90~95%，测试时间 96 小时再置放于室温下 1~2 小时。 Mate applicable FFC/FPC and expose to 60 ± 2°C, relative humidity 90 to 95% for 96 hours. Upon completion of the exposure period, the test specimens shall be conditioned at ambient room conditions for 1 to 2 hours, after which the specified measurements shall be
		耐电压 Dielectric Strength	需能符合耐电压测试 No Breakdown	

<b>深圳市钜硕电子有限公司</b> SHENZHEN JUSHUO ELECTRONIC CO.,LTD		文件編號：	<b>JSQA-FPC01086</b>
		修訂日期：	<b>2011-09-18</b>
<b>0.3P 1.0H</b> <b>FPC/FFC</b>	<b>Product Specification</b>	版 次：	<b>Rev A</b>
		頁 次：	<b>5/9</b>

		绝缘阻抗 Insulation Resistance	[ 50 ] MΩ 以上. [ 50 ] MΩ Min.	performed. (EIA-364-31B /MIL-STD-202 Method 103)
10	冷热冲击 Temperature Cycling	外观 Appearance	目视外观无任何损坏异状 No Damage	将样品与适合之 FFC/FPC 连接, 承受 5 cycles 冷热冲击后,置放于室温下 1~2 小时. 1 cycle time 如下:a) -55±3°C,30 分钟 b) +85±3°C,30 分钟 Mate applicable FFC/FPC and subject to the following conditions for 5 cycles. Upon completion of the exposure period, the test specimens shall be conditioned at ambient room conditions for 1 to 2 hours, after which the specified measurements shall be performed 1 cycle a) -55±3°C,30minutes b) +85±3°C,30minutes (Transit time shall be within 3 minutes) (EIA-364-17B)
		接触阻抗 Contact Resistance	[100] mΩ 以下. [100] mΩ Max.	
11	盐水喷雾 Salt Spray	外观 Appearance	目视外观无任何损坏异状 No Damage	将样品与适合之 FFC/FPC 连接, 使用 5±1%浓度盐水, 测试温度 35±2°C, 测试时间 48±4 小时,后于室温下使用清水 冲洗后再干燥。 (JIS C0023 / MIL-STD-202 Method 101) Mate applicable FPC and expose to the following salt mist conditions. Upon completion of the exposure period, salt deposits shall be removed by a gentle wash or dip in running water, after which the specified NaCl solution Concentration: 5 ± 1% Spray time:48 ± 4 hours Ambient temperature: 35 ± 2°C (EIA-364-26B, Condition B /MIL-STD-202 Method 101)
		接触阻抗 Contact Resistance	[ 100 ] mΩ 以下. [ 100 ] mΩ Max.	
12	焊锡性 Solder ability	润湿性 Solder Wetting	润湿面积 95%以上, 并不得有漏焊 针孔现象 95% of immersed area must show no voids, pin holes.	锡温 245±5°C, 将导电端子浸入锡炉液面至 Housing 距离锡面 0.1mm 位置,焊锡时间 3~5 秒。 Tip of solder tails and fitting nails into the molten solder (held at 245±5°C) up to 0.1mm from the bottom of the housing for 3~5 seconds. (JESD22-B102D, Condition C)
13	温升 Temperature Rising	30°C Max. Under loaded rating current		Contact series-wired, apply test current of loaded rating current to the circuit, and measure the temperature rising by probing on soldered areas of contacts, after the temperature becomes stabilized deduct ambient temperature from the measured value.

测试项目(Test Item)	规格(Requirement)	测试方式/条件(Test Condition)	
<b>环境特性及其他性能(Environment Performance and Others)</b>			
14	焊锡耐热性 Resistance to Soldering Heat	外观 Appearance	目视外观无任何损坏异状 No Damage
			使用红外线回焊时请参考第 4 点 When reflowing...Refer to paragraph 4.  使用烙铁手焊时须符合下述焊锡条件 Soldering iron method 0.2mm from terminal tip and fitting nail tip. Soldering time: 5 seconds Max. Solder temperature : 370~400°C

<b>深圳市钜硕电子有限公司</b> SHENZHEN JUSHUO ELECTRONIC CO.,LTD		文件編號：	<b>JSQA-FPC01086</b>
		修訂日期：	<b>2011-09-18</b>
<b>0.3P 1.0H</b> <b>FPC/FFC</b>	<b>Product Specification</b>	版 次：	<b>Rev A</b>
		頁 次：	<b>6/9</b>

#### 4. Resistance to flow solder heat

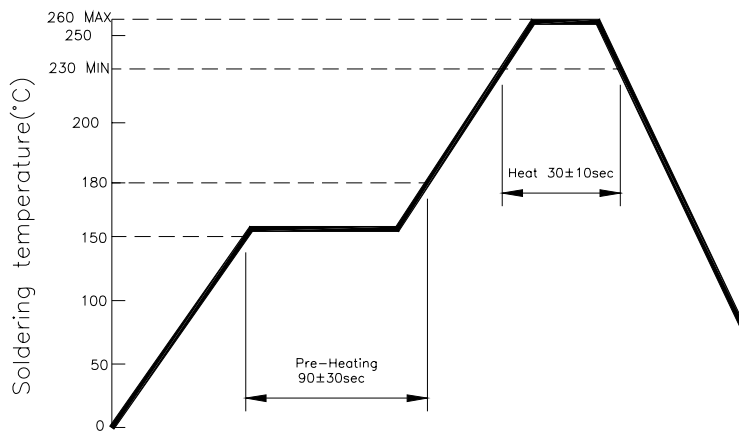

**NOTE:** Please check the re-flow soldering condition by your own devices beforehand.  
 Because the condition changes by the soldering devices, p.c. boards, and so on.

<b>深圳市钜硕电子有限公司</b> SHENZHEN JUSHUO ELECTRONIC CO.,LTD		文件編號：	JSQA-FPC01086
		修訂日期：	2011-09-18
<b>0.3P 1.0H</b> <b>FPC/FFC</b>	<b>Product Specification</b>	版 次：	Rev A
		頁 次：	7/9

### 5. Qualification and Requalification Test

Test or Examination	Test Group								
	A	B	C	D	E	F	G	H	I
	Test Sequence								
Examination of Product	1,9	1,4	1,5	1,5	1,5	1,5	1,3	1,3	1,3
Contact Resistance	2,6		2,4	2,4	2,4	2,4			
Dielectric withstanding Voltage	3,7								
Insulation Resistance	4,8								
FPC/FFC Retention Force		2							
Durability		3							
Vibration			3						
Mechanical Shock				3					
Humidity	5								
Temperature Rising									2
Temperature Cycling					3				
Salt Spray						3			
Solder ability							2		
Resistance to Soldering Heat								2	

### 6. Packing Specification

#### 6.1 Tape and Reel Dimensions:

See attached Packing drawings.

#### 6.2 Packing Specification

See attached Packing drawings.

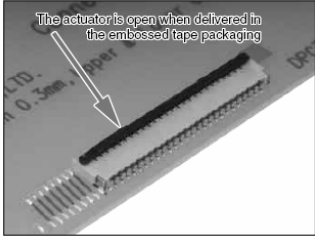
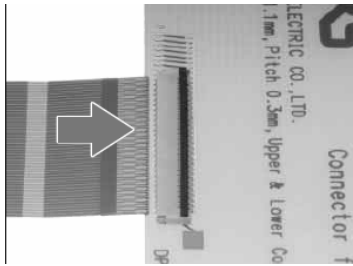
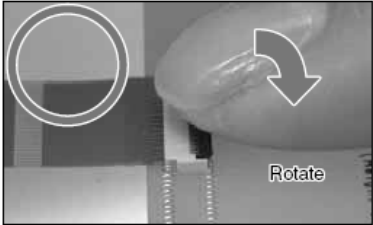
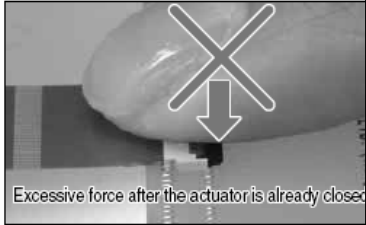
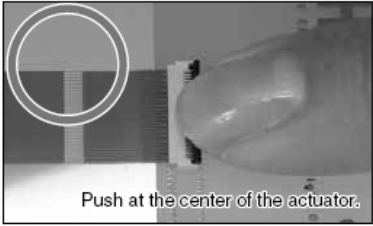
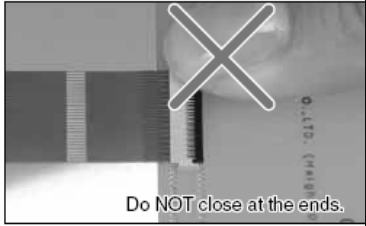

7.Instruction Upon Usage(操作说明)

<p><b>1. As delivered</b> Delivered with the actuator open. There is no need to operate the actuator prior to the insertion of the FPC.</p>		
<p><b>2. FPC insertion</b> Align the FPC perpendicular with the connector and insert it firmly all the way.</p>		
<p><b>3. Locking</b> After FPC/FFC insertion, rotate the actuator down to a full stop, pushing it at the center.</p>		
		

**4. FPC removal(Lock release)**

Carefully rotate the actuator up to 90°, lifting it at the center.

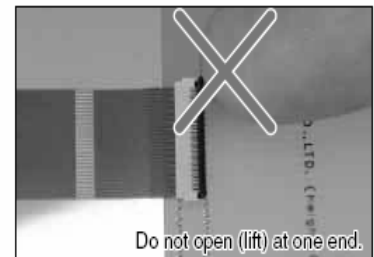
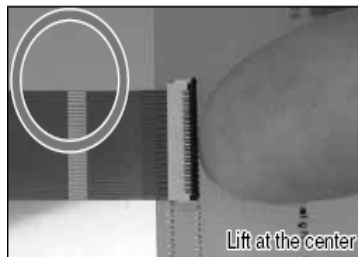
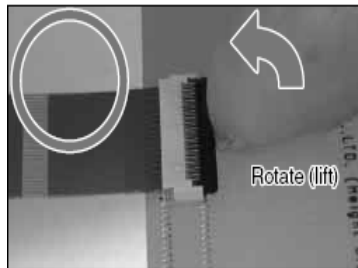

**5. Warning!!**

The roughness of PCB board must be in 0.1mm max.

